

brushless DC driven actuators for fast operation of dampers up to 12.5 square feet or 1.2 square meters based upon 4 in.lb. per square foot

Description

The BBMF2000 NA and BBMF2060 NA are microprocessor based actuators with conditioned feedback that operate on 24 volt nominal power supply. Powered by brushless DC technology, these motors deliver a minimum of 50 in.lb. or 5.6 Nm. torque at rated voltage. The minimum duration through **the 90 degree angle of rotation is 6 seconds**. The direction of rotation is reversible.

Features

Both models are factory programmed for a 90 degree stroke and full span modulating control input and will function as designed within those parameters. However, the motors may be reprogrammed by the field operative to respond to a PWM modulating signal or a digital control signal, to electronically adjust the stroke or to limit the control response of the actuator to a portion of the 2-10VDC input signal.

CONTROL SIGNAL

The actuators will respond to either analog, PWM or digital control. Both actuator models are factory set to respond to the analog signal, 2-10VDC, which may be externally wired in the field to accept 4-20mA. The actuators may be wired and reprogrammed to respond to a PWM signal with a time base of either 0.1 to 5 seconds or 0.1 to 25 seconds, 2 position or 3 point floating control (digital). The control signal programming may be changed back and forth between analog, PWM and digital as many times as necessary. The feedback signal which is 4-20mA may be externally wired to produce a 2-10VDC signal.

STROKE ADJUSTMENT

The actuators are factory programmed with a 90 degree stroke. In the event that the stroke of the damper is less than 90 degrees, the stroke must be limited to prevent damage to the damper. Once the device has been installed as directed, a stroke of equal to or greater than 45 degrees and less than 90 degrees may be established by repositioning the 90 degree stop screw between 45 and 90 degrees. The actuator will require recalibration during its inaugural operation so that the new location of the physical end stop is retained by the microprocessor. (Refer to Calibration on page 5).

*U.S.A. Patent #5,278,454 - International Patents Pending



Subsequently, as the actuator travels through the arc, it will anticipate and stop as it reaches either position where it will remain, motionless, until activated by the control signal. This capability greatly reduces stress on both the damper and the actuator ensuring long life. Lastly, in the event that a change in the stroke is necessary, the actuator may be readjusted and recalibrated as many times as necessary.

ZERO & SPAN

In addition, these actuators are equipped with a zero & span feature which may be field set to adjust the control response of the motor to a portion of the 0-10VDC input signal. This allows for the sequencing of several motors off the same input signal. Once the actuator has been programmed (refer to Calibration on page 5) with the required parameters, the information is permanently stored in the chip. Due to the fact that the microprocessor is supported by nonvolatile memory (EEPROM) and internal feedback, the motor will not have to re-stroke to "find itself" on start up or following a power outage or subsequent to repositioning with the clutch.

The Enerdrive System

The **Enerdrive System*** is a patented electronic circuit integral to the PC board of the BBMF2060 NA that relies upon the inherent characteristics of a super capacitor to retain energy. Initiated by an interruption of the power supply, the **Enerdrive System** engages and, utilizing this stored energy, **drives the motor at full rated torque** in a clockwise or counterclockwise direction such that the controlled device arrives at a fully closed or fully open position where it can remain indefinitely or until the power is restored. As this is an electronic, not a mechanical, device, the life-span is unlimited if used in accordance with the instructions on installation and operation.

Distributed By:

GLOBAL CONTROLS, INC.
3008-B 16TH AVE. W. SEATTLE, WA 98119
(800) 821-4863 (206) 282-4666 (206) 282-4888 Fax
info@global-controls.net www.global-controls.net

Model Selection

BBMF2000 NA
BBMF2060 NA

Fast Acting Multi Signal Actuator with Feedback
Fast Acting Multi Signal Actuator with Feedback & the
Enerdrive System

Actuator Specifications

Power Supply Maximum Power Consumption	24VAC +/-10% or 30VDC +/-10% 24VA at 26VAC
Electrical Connections	18 AWG Minimum, 25 ft./7.6 m. Maximum per Actuator Screw Terminals
Inlet Bushing	One 5/8 in./15.9 mm. & One 7/8 in./22.2 mm. Knock Outs
Control Signals	ANALOG: A) 2-10VDC; or B) May be Externally Wired with a 500 ohm Resistor (Supplied) for 4-20mA Zero & Span Adjustable PULSE WIDTH MODULATION: Time Base of 0.1 to 5 Sec./20 mS Resolution or 0.1 to 25 Sec./100 mS Resolution Selected by Dip Switch Position SWITCHHOT: Triac or Dry Contact 40mA Maximum Switching Current SWITCHNEUTRAL: NPN Transistor, SCR, Triac or Dry Contact 75mA Maximum Switching Current DIGITAL: 3 wire/2 position or 4 Wire/3 Point Floating
Torque	50 in.lb. or 5.6 Nm. at Rated Voltage
Angle of Rotation Direction of Rotation	0°-90°, Mechanically Adjustable Reversible
Rotation Time Through 90°	6 Seconds
Ambient Temperature	0°F to +122°F or -18°C to +50°C
Feedback Potentiometer	4-20mA Output Which May be Externally Wired with a 500 ohm Resistor (Supplied) to Produce a 2-10VDC Signal
Gear Train Enclosure Weight	Die Cast Zinc with a Steel Base 3 lbs. or 1.4 kilos

Distributed By:

GLOBAL CONTROLS, INC.
3008-B 16TH AVE. W. SEATTLE, WA 98119
(800) 821-4863 (206) 282-4666 (206) 282-4888 Fax
info@global-controls.net www.global-controls.net

Ancillary Products

ARM24BB
ARM36BB
BDM
BJ516
DCA
ELBB
HUMISEAL
MINI HANDLE
MCABB
RH1

Assembly for Remote Mounting kit with a 24" length of 5/16" rod
Assembly for Remote Mounting kit with a 36" length of 5/16" rod
Blade Damper Mount for remote mounting. Requires ARM24BB or ARM36BB
Ball Joint for 5/16" rod. A component of ARM24BB & ARM36BB
Damper Crank Arm which accepts up to a 1/2" jack shaft.
'L' Standoff Bracket. Requires an ARM24BB or ARM36BB
A liquid plastic that is sprayed on the PC board to form a transparent barrier. Intended for use in high humidity conditions
Handle for the Universal Clamp Assembly
Motor Crank Arm. A component of the ARM24BB & ARM36BB
A Rain Hood or protective cover

Actuator Schematic & Installation

Easily installed, the actuator mounts directly on up to a 3/8 inch/9.5 mm. square or 1/2 inch or 15 mm. nominal round jack shaft and is held securely in place by means of the supplied mounting bracket. Once the actuator is in place, the damper blades may be manually positioned by depressing the internal clutch which is located under the motor cover and rotating the universal clamp assembly. This procedure is facilitated by a handle that is available separately. Accessory kits and bracket allow for remote mounting.

All actuators are shipped with the factory settings described below and require no additional adjustments!

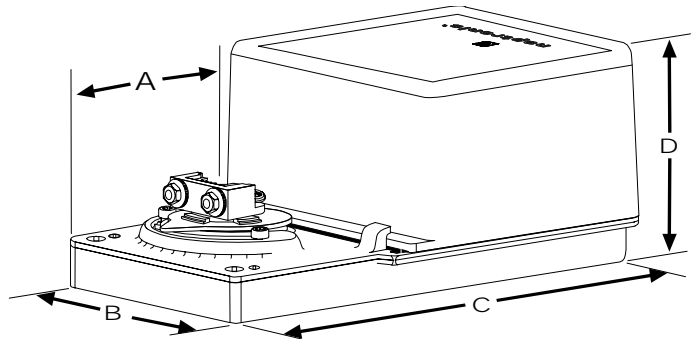

FACTORY SETTINGS	
CONTROL SIGNAL	2 - 10VDC
FEEDBACK	4 - 20mA
STROKE	90 DEGREES
DIRECTION	0 TO 90 DEGREES - DIRECT ACTING
ENERDRIVE	"FAIL" TO THE 0 DEGREE POSITION

DIM.	INCHES	CENTIMETERS
A	1.50	3.81
B	3.26	8.28
C	6.60	16.75
D	3.01	7.64

Distributed By:

GLOBAL CONTROLS, INC.
3008-B 16TH AVE. W. SEATTLE, WA 98119
(800) 821-4863 (206) 282-4666 (206) 282-4888 Fax
info@global-controls.net www.global-controls.net

Wiring Schematics

INSTALLATION REQUIREMENTS

It is recommended that all **NEPTRONIC** products be wired to a separate transformer and that that transformer shall service only **NEPTRONIC** products. This precaution will prevent interference with, and/or possible damage to, incompatible equipment of other manufacture. **CAUTION!** When multiple actuators are wired on a single transformer, polarity must be respected! Long wiring runs create voltage drops which may affect the actuator's performance.

3 POINT FLOATING CONTROL SIGNAL

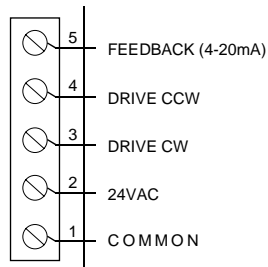

PWM CONTROL SIGNAL

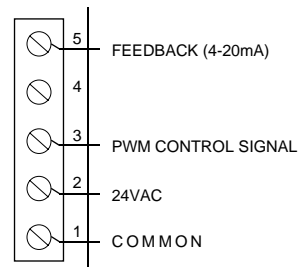

2 POSITION CONTROL SIGNAL

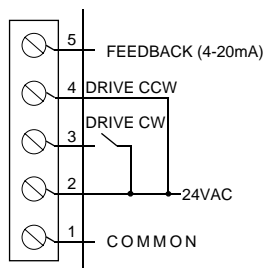

2-10VDC CONTROL SIGNAL

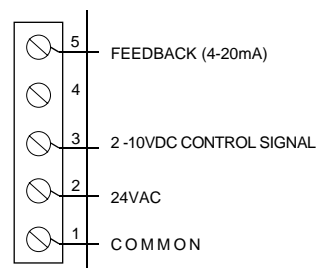

FOR 4-20mA CONTROL SIGNAL

Wire the actuator according to the 2-10VDC control signal wiring diagram. Connect one of the supplied 500 ohm resistors between terminals 1 and 3.

FOR 2-10VDC OUTPUT FEEDBACK

For any of the above wiring configurations, connect one of the supplied 500 ohm resistors between terminals 1 and 5 to change the output feedback from 4-20mA to 2-10VDC.

SIGNAL INPUT SELECTION

The actuators are factory set to accept the analog mode, i.e. 2-10VDC; however, to accept PWM, 2 position or 3 Point Floating control or to reestablish analog control, follow this sequence.

1. Remove power to the actuator.
2. Put the 3 dip switches on in the 'OFF' position.
3. Apply power and, within 10 seconds, depress & release the Reset Button. The LED should be blinking.
4. Perform one of the following:

A. For Analog Control, turn Dip Switch #3 first 'ON' and then 'OFF'. The actuator will now accept 2-10VDC control.

B. For PWM Control, turn Dip Switch #2 first 'ON' and then 'OFF'. The actuator will now accept PWM control.

C. For 2 position or 3 Point Floating Control, turn Dip Switch #1 first 'ON' and then 'OFF'. The actuator will now accept digital control.

If the actuator has been wired correctly, the motor will now respond to the input signal. The dip switches on S1 may now be set to perform the functions described below.

SPECIAL CONSIDERATION FOR DIGITAL CONTROL

In this mode, the actuators are sensitive to induced electrical voltages from other sources. To prevent such interference, wire one 2.2k ohm 0.5W resistor between pin 4 and pin 1 and a second 2.2k ohm 0.5W resistor between pin 3 and pin 1. These resistors are supplied.

THE RESET BUTTON

The Reset Button is to be pressed only during calibration of either the Auto Stroking or Zero & Span or reprogramming the control signal as instructed.

DIP SWITCH POSITIONS

Dip Switch #1 controls the direction of rotation. For REVERSE acting, place the switch in the 'ON' position; for DIRECT acting, place the switch in the 'OFF' position.

Dip Switch #2 determines the fail safe direction either clockwise or counterclockwise. The factory setting is in the 'OFF' position to 'fail' CCW to the 0° position. To 'fail' to the 90° position, place the switch in the 'ON' position.

Dip Switch #3 determines the Time Base for actuators in the PWM control mode. For 0.1 to 5 sec., place the switch in the 'ON' position. For 0.1 to 25 sec., place it in the 'OFF' position.

DIP SWITCHES

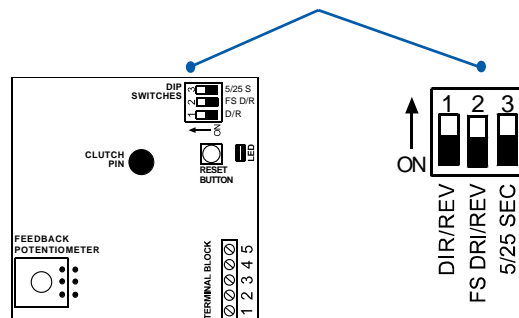

Distributed By:

GLOBAL CONTROLS, INC.
3008-B 16TH AVE. W. SEATTLE, WA 98119
(800) 821-4863 (206) 282-4666 (206) 282-4888 Fax
info@global-controls.net www.global-controls.net

Calibration

The BBMF2000 NA and the BBMF2060 NA are microprocessor based modulating motors with an Auto Stroking feature and memory so that the actuator will not have to re-stroke to find itself in the following circumstances:

- (A) upon initial power-up
- (B) after a power failure or
- (C) if the motor is manually repositioned with the clutch.

These motors are also equipped with a Zero and Span feature that allows sequencing of two actuators.

THE AUTO STROKING FEATURE

The unit is factory tested and set with a 0-90° stroke for 2-10VDC control input. **If less than a 90° stroke is required, the actuator must be calibrated using the following procedure.** Since the actuator starts the auto stroking procedure in a clockwise rotation, the damper blades must be manually adjusted to the full counterclockwise position.

- 1) Install the actuator on the damper but do not tighten the universal clamp assembly. Remove the cover.
- 2) Simultaneously depress the motor clutch which is located on the PC board and rotate the universal clamp assembly so that the start position of the motor and the damper coincide. Tighten the universal clamp assembly.
- 3) Adjust the 90° mechanical stop screw at the desired degree of rotation between 45° and 90°.
- 4) Wire the actuator according to the wiring diagram that corresponds to the control signal. Apply power. The LED will be illuminated for approximately 10 seconds.
- 5) **Wait until the LED is extinguished!** Press and release the Reset Button which is located next to the Dip Switches on the PC board to initiate the Auto Stroking feature. The LED will light up and the actuator will start to auto stroke.
- 6) When the actuator reaches the mechanical stop screw, it will automatically reprogram such that the position of the end stop will now represent 10VDC. The actuator will now return to the full CCW start position. The LED is extinguished and the process is complete. Replace the cover and secure.

THE ZERO & SPAN FEATURE

This feature is only applicable to 2-10VDC installations.

- 1) Install the actuator on the damper and remove the cover. Wire the motor according to the wiring diagram that corresponds to the control signal. Apply power. The LED will be illuminated.
- 2) **Within the first 10 seconds of initiating the power supply**, press and hold the Reset Button which is located next to the dip switches on the PC board, until the small LED blinks once. This initiates the Zero & Span calibration.
- 3) Release the Reset Button. The LED is now constantly illuminated.
- 4) The Zero or start value may be 0 volts. To set the Zero value, apply a DC voltage across pins 1 and 3 and adjust the voltage until the desired value is indicated on the test meter. When this occurs, depress and release the Reset Button. Wait until the LED blinks once; this single blink indicates that the Zero value has been accepted by the actuator.
- 5) The Span or stop value must be at least 3 volts greater than the Zero or start value. To set the Span value, measure the voltage between terminals 1 and 3 until the desired value is indicated on your test meter. Depress the Reset Button once. Wait until the LED blinks once; this single blink indicates that the Span value has been accepted by the actuator. After 2 seconds the LED will cease to be illuminated indicating that the actuator has resumed normal operations.
- 6) Remove the test equipment and replace the cover. Record the Zero & Span values in the spaces provided on the product label for future reference.

RE-CALIBRATION

The actuator may be re-calibrated to accept different Zero and Span values. To accomplish this, remove the power supply for a sufficient length of time for the motor to recognize a power loss (ex. 15 seconds) and then follow steps 2 through 6 in THE ZERO & SPAN FEATURE.

To erase the Zero & Span, follow the **SIGNAL INPUT SELECTION** directions on page 4 for Analog Control. The actuator will then respond to 2-10VDC.

Distributed By:

GLOBAL CONTROLS, INC.
3008-B 16TH AVE. W. SEATTLE, WA 98119
(800) 821-4863 (206) 282-4666 (206) 282-4888 Fax
info@global-controls.net www.global-controls.net

Electronic Damper Actuators

BBMF2000 NA
BBMF2060 NA

NATIONAL ENVIRONMENTAL PRODUCTS LTD., INC. MAINTAINS A POLICY OF CONTINUAL PRODUCT DEVELOPMENT; THEREFORE, IN THE INTEREST OF TECHNICAL IMPROVEMENTS, THE FIRM RESERVES THE RIGHT TO CHANGE THE DESIGN, SPECIFICATIONS OR COMPONENTS OF THE EQUIPMENT WITHOUT PRIOR NOTICE.

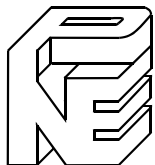

**national
environmental
products**
montreal,canada

GLOBAL CONTROLS, INC.

3008-B 16TH AVE. W. SEATTLE, WA 98119
(800) 821-4863 (206) 282-4666 (206) 282-4888 Fax
info@global-controls.net www.global-controls.net